

A large, stylized graphic of a green leaf or blade, curved from the top left towards the bottom right, framing the central text.

ALBIN ALH
HOSE PUMP

ALBIN PUMP ALH - HOSE PUMPS

Albin Pump ALH is a hose pump of the latest design. We have combined the best available materials with smart design solutions in order to maximise running time and minimise maintenance.

Two shoes mounted at 180° on a rotating wheel compress successively a reinforced rubber hose that contains a fluid to be pumped. The motion of the shoes compress the rubber against the pump housing creates continuous suction at the inlet of the pump and pushes the fluid to the outlet of the pump. The sealed pump casing contains a lubricant that reduces friction of the shoes moving over the rubber hose. The pumped fluid is in contact only with the interior of the rubber hose, thus permitting the pumping of a wide variety of reactive fluids.

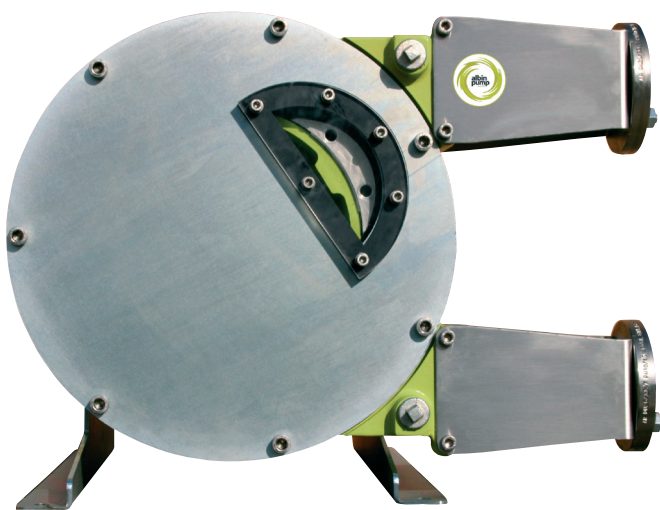

This pump summarizes what we at Albin Pump want to achieve: better pump solutions for our customers.

Our design enhances the pump's simplicity and robust principle.

ADVANTAGES

- No mechanical seal or stuffing box
- Robust, entirely of ductile iron
- Suitable for aggressive or viscous fluids
- Dosing of very corrosive chemicals
- Fully self-priming up to 9,8 m
- Damage-free continuous dry running
- Outlet pressures up to 15 bar
- Very easy maintenance
- Two-year warranty
- Plug and Play
- Perfect volumetric flow
- Reversible flow
- Close coupled with gearbox protection
- Low sound level: < 70 dB at 1meter

EXPERIENCED NEWTHINKER

30 years experience in hose pumps.

The ALH hose pump is in many ways the future of pumping. The ALH series pump is a fantastically simple pump with a wide range, up to 150 m³/h and 15 bars, that can handle most fluids in most applications.

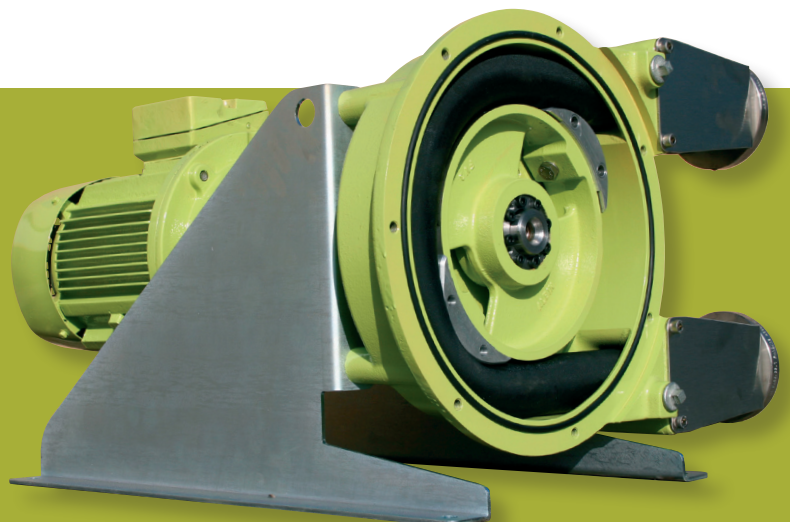

EXPERIENCED NEWTHINKER - KEEP IT SIMPLE

The ALH pump is very easy to use and maintain and therefore addresses what we at Albin Pump see as two of the key customer issues:

The need to lower costs and to reduce downtime

This is done by using a pump without valves, pistons, stators or rotating elements in the fluid.

The ALH series is designed to make hose changes quick and easy with no technical knowledge required.

OPTIONS

- Twinhead pump, several pump bodies in-line driven by the same gear motor.
- Special executions and different connections such as SMS, Clamp, DIN, ANSI, coupling and cover...etc
- Pump rollers for pump without lubricant
- Hose rupture detector and revolution counter
- **ATEX II & I certification**

Any other pumping requirements can be considered



The Albin Pump AP in-line pulsation dampener will reduce vibration and water hammers in your piping therefore increasing the hose life.

ALBIN PUMP HOSE

We only work with high quality compounded rubbers, reinforced with 2 to 6 individual layers of braided polyamide and with an outer layer made to strict tolerances to ensure perfect compression.

The characteristics of Albin hoses enable them to last approximately 30% longer than other hoses on the market. They also fit the majority of other hose pumps.

ALBIN ALH HOSE CONSTRUCTION

For the hose inner layers, 5 materials are available to suit the diversity of the pumped fluids:

- **NR** (natural rubber)
(White marking)
- **NBR** (Buna)
(Yellow marking)
- **NBR Food** (Buna)
(White & yellow marking)
- **EPDM** (Red marking)
- **HYPALON** (Blue marking)

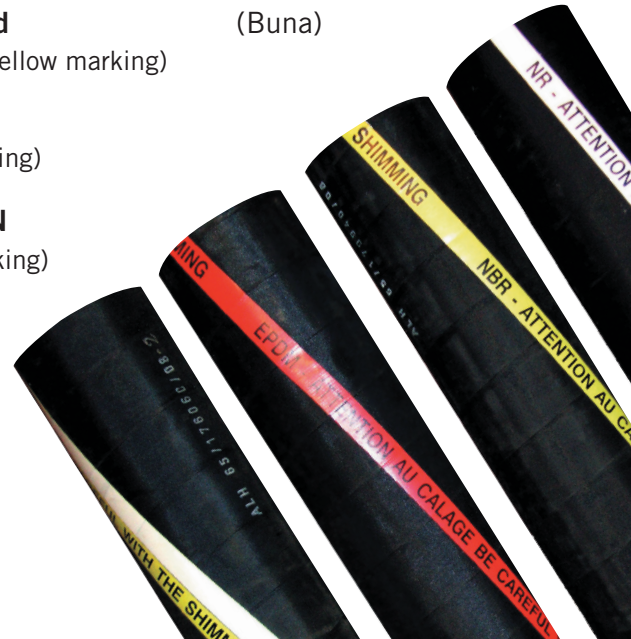

TYPICAL APPLICATIONS

WATER TREATMENT lime cream, ferrous chloride, activated carbon, reagent feed, coagulant, flocculate dispersion, alum, sludge and foams. **MINERAL PROCESSING** sludge with viscosity up to 60 000 Cps, clay up to 800g/l, particle size: 30mm, lead sulfate, pyrite, SABX, cyanide, various acids. **CERAMIC** barbotine, mould filling, filter press feeding. **BUILDING** fibrous mortar, plaster, light concrete, cement flooring.

CHEMICAL INDUSTRY various acids, PVDF latex, alcohol, soap, non aromatic solvents. **FOOD INDUSTRY** tomato sauce, mash potatoes, gelatin, beer yeast, fish paste, olive oil, wine. **PAINT** water based paint, acrylics, pigments, ink, wall coating. **PAPER MILLS** latex, kaolin, paper waste sludge, various chemical dosing. **AGRICULTURE** manure, fertilizer. **SUGAR MILLS** molasse, liquid sugar and various chemicals.

ALH 05 - 20

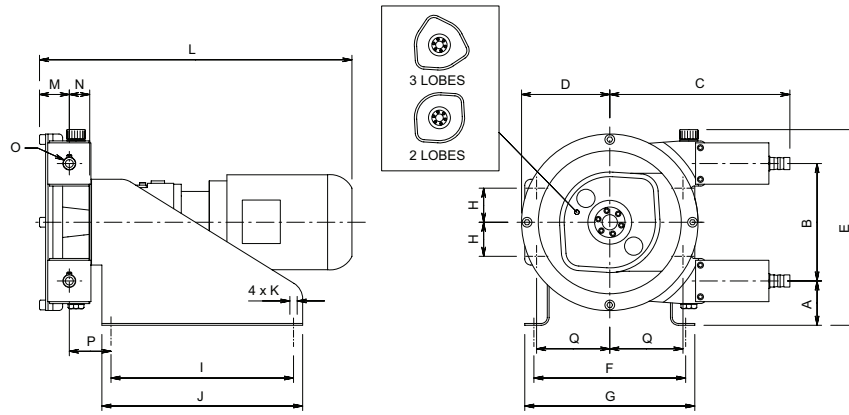

ALH 25 - 40

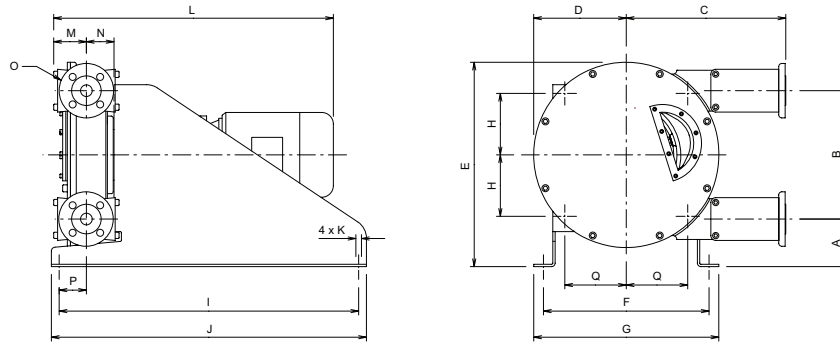

ALHX 40 - 125

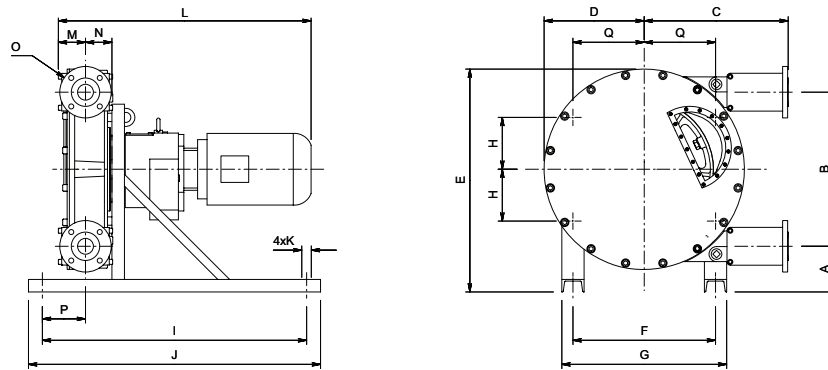

ALL DIMENSIONS AND TECHNICAL DATA IS SUBJECT TO CHANGE WITHOUT NOTICE

Dimensions

* Hose tail

TYPE	A	B	C	D	E	F	G	H	I	J	K	L	M	N	O (Flange ISO)	P	Q
ALH 05	103,5	115	226	95	256	220	240	33,5	260	280	4xø9	-	46,5	34,5	ø16 *	56	81,25
ALH 10	103,5	115	226	95	256	220	240	33,5	260	280	4xø9	-	46,5	34,5	ø16 *	56	81,25
ALH 15	73	193	296	145	322	250	280	51,75	300	330	4xø13	-	49	35,5	ø20 *	68,8	124,75
ALH 20	73	193	296	145	322	250	280	51,75	300	330	4xø13	-	49	35,5	ø25 *	68,8	124,75
ALH 25	95	262	355,5	190	416	311	351	110	560	600	4xø13	-	65	69	DN25 PN16	61	110
ALH 32	122,5	330	435,5	238	525,5	426	476	157,75	770	810	4xø13	-	83	89	DN32 PN16	109	157,75
ALH 40	122,5	330	435,5	238	525,5	426	476	157,75	770	810	4xø13	-	83	89	DN40 PN16	109	157,75
ALHX 40	110	430	400	291	616	340	420	170	850	950	4xø19	-	75	86	DN40 PN16	87	170
ALH 50	164,5	554	517,5	360	801,5	513	593	186,5	950	1050	4xø19	-	94,5	102	DN50 PN16	152	256,5
ALH 65	164,5	554	517,5	360	801,5	513	593	186,5	950	1050	4xø19	-	94,5	102	DN65 PN16	152	256,5
ALHX 80	154	746	604	473	1004	580	680	290	1150	1250	4xø19	-	129	123	DN80 PN16	117	290
ALH 80	262	876	803	555	1320	690	830	345	1300	1400	4xø27	-	140,5	142	DN80 PN16	210	345
ALH 100	300	1040	887	685	1680	820	960	410	1900	2000	4xø27	-	149	174	DN100 PN16	295	410
ALH 125	263,5	1273	1038	785	1750	1000	1140	500	1900	2000	4xø27	-	300	232	DN125 PN16	660	500

FLOW TABLE (L/H)

TYPE	10 RPM	20 RPM	40 RPM	60 RPM	80 RPM	100 RPM	120 RPM	140 RPM
ALH 05 (3 lobes)	3.4	6.8	13.6	20.4				
ALH10 (3 lobes)	10	20	40	60				
ALH 10	15	30	60	90	120	150	180	
ALH 15	50	100	200	300	400	500	600	
ALH 20	65	170	340	500	670	850	970	
ALH 25	200	400	800	1 200	1 600	2 000	2 400	2 800
ALH 32	375	750	1 500	2 250	3 000	3 750	4 500	5 250
ALH 40	565	1 170	2 340	3 510	4 680	6 850	7 020	8 190
ALHX 40	800	1 600	3 200	4 800	6 400	8 000		
ALH 50	1750	3 500	7 000	10 500	14 000	17 500		
ALH 65	2300	4 600	9 200	13 800	18 400	23 000		

TYPE	10 RPM	20 RPM	30 RPM	35 RPM	40 RPM	45 RPM	50 RPM
ALHX 80	5 500	11 000	16 500	19 250	22 000	24 750	27 500
ALH 80	7 000	14 000	21 000	24 500	28 000	31 500	35 000
ALH 100	12 000	24 000	36 000	42 000	48 000	54 000	
ALH 125	22 000	44 000	66 000	77 000	88 000		

 Continuous use (L/h)

 Usage intermittent (L/h)

 Occasional use (L/h)
(>1 hours/day)

ALBIN ALHS SERIE

For customers who require a long shaft technology, Albin Pump has also developed the ALHS series. These pumps are equipped with a removable bearing case for easy bearing maintenance and can be converted into a close coupling ALH type pump at any time.



HOW TO USE THE PUMP CURVES

How to use the curves:

1. Select the required flow. This gives you the required pump speed.
2. Move upwards to the calculated discharge pressure.
3. Move to the left for the installed motor power.
4. Determine the fluid's max. temperature.
5. Move to the left to the calculated discharge pressure.
6. Move downwards to determine your maximum allowed pump speed for the fluids temperature.

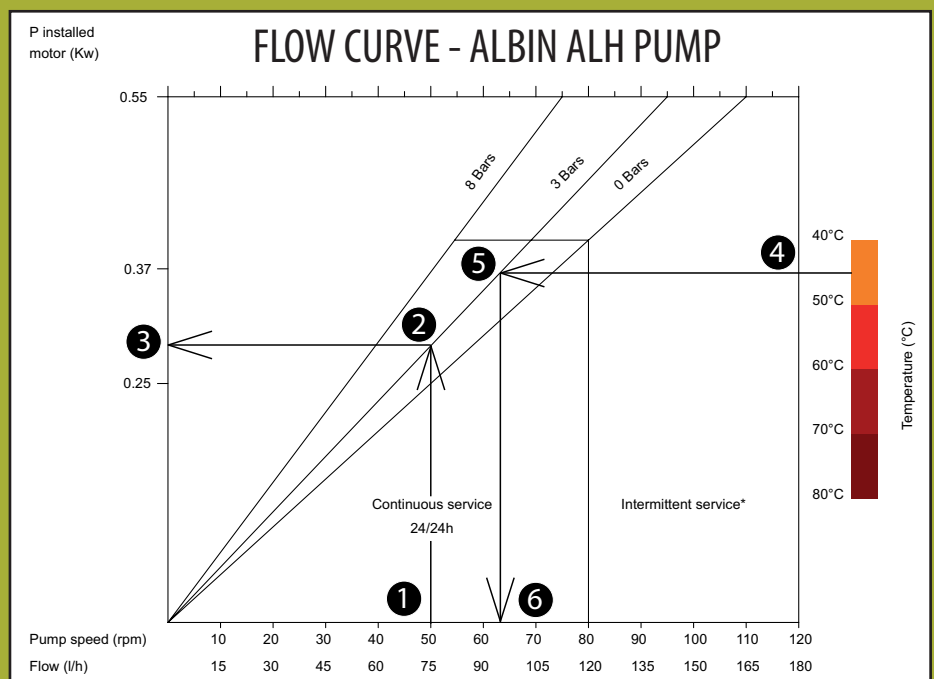

FLOW CURVES ALBIN ALH

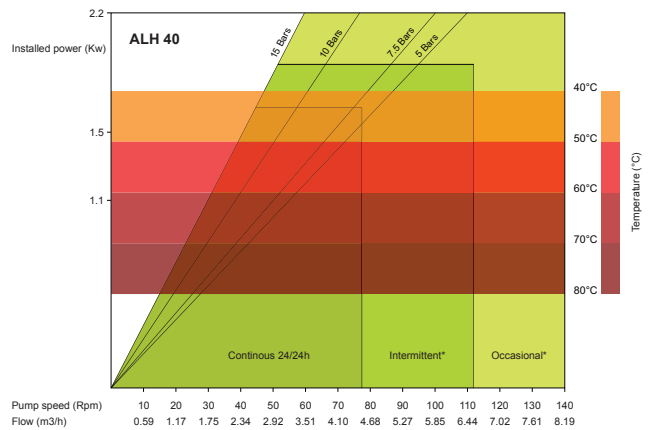
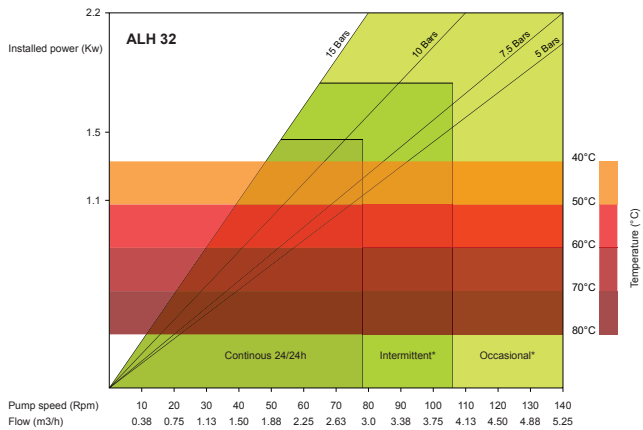
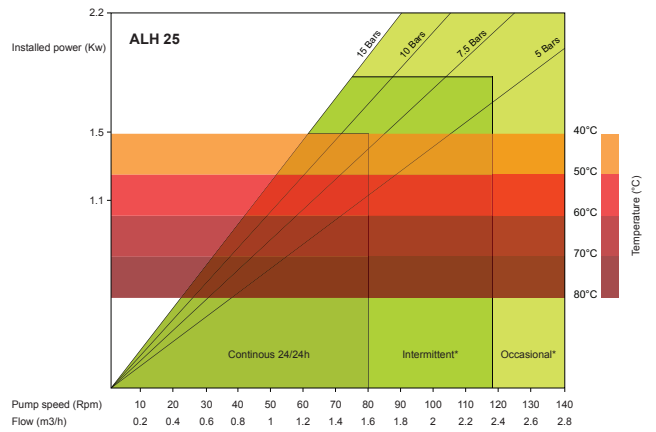
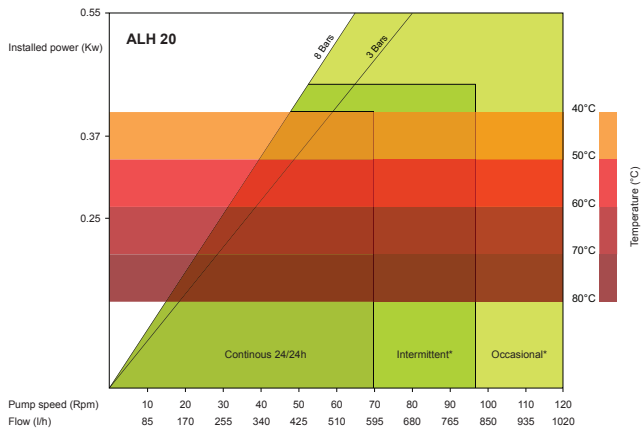
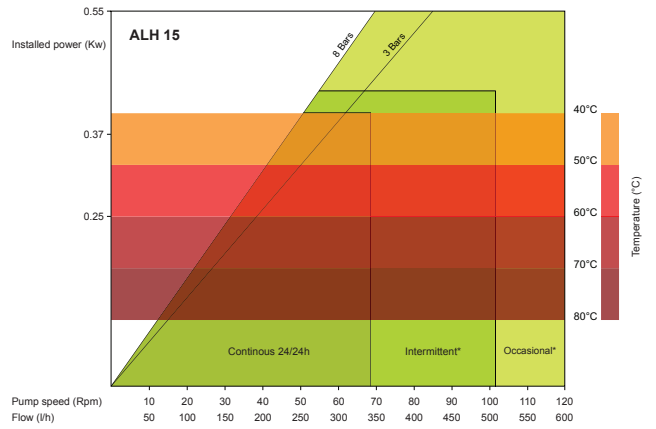
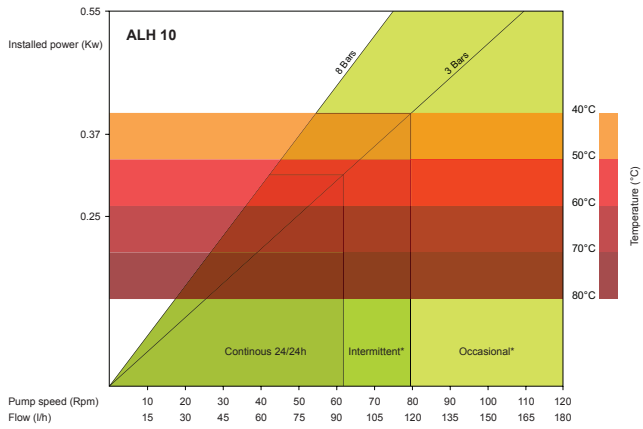
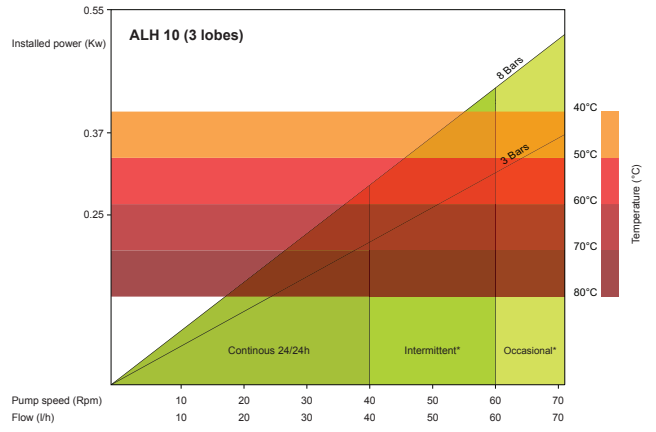
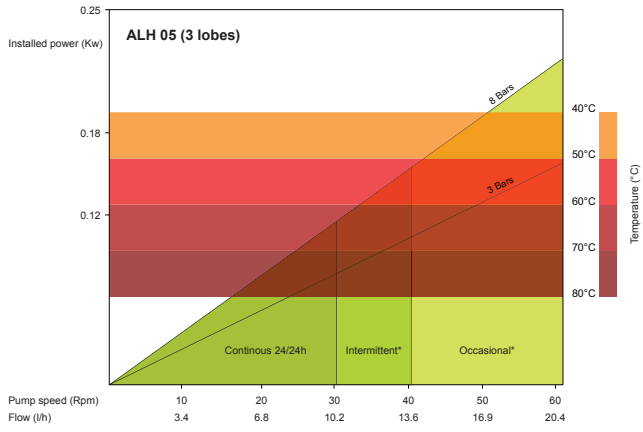

* Intermittent use: Minimum of 1 hour stop after 2 hours use * Occasional use: Maximum 1 hour per day

FLOW CURVES ALBIN ALH

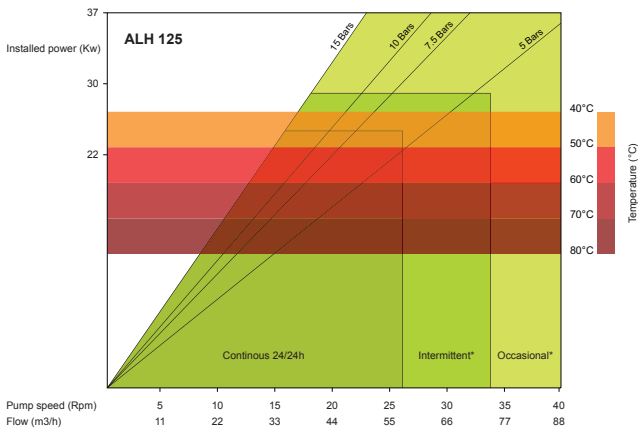
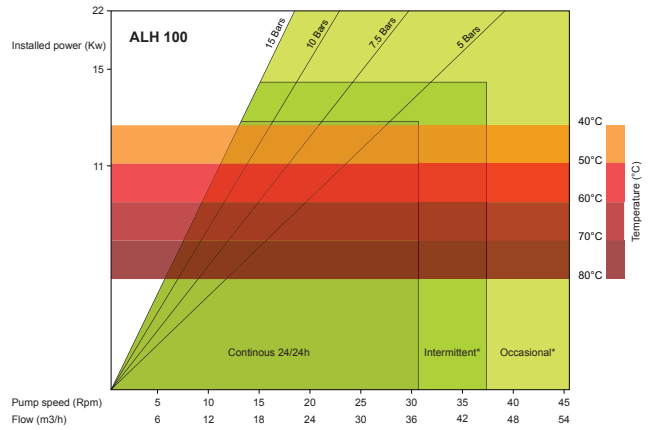
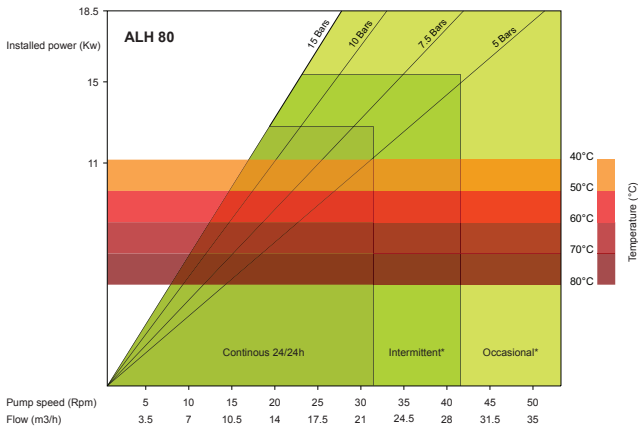
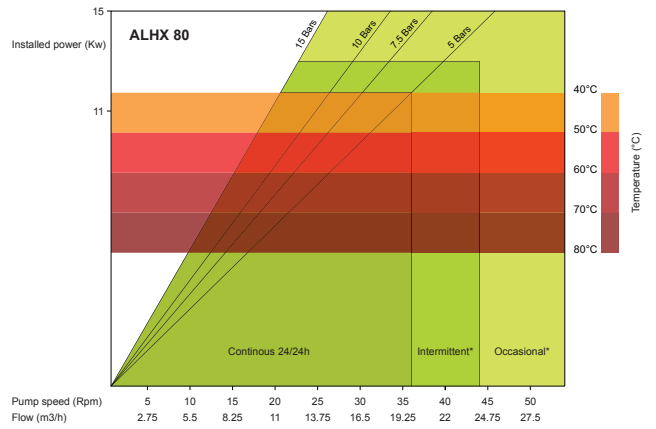
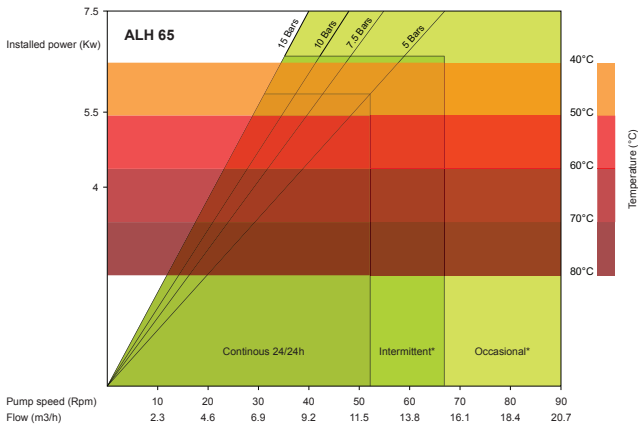
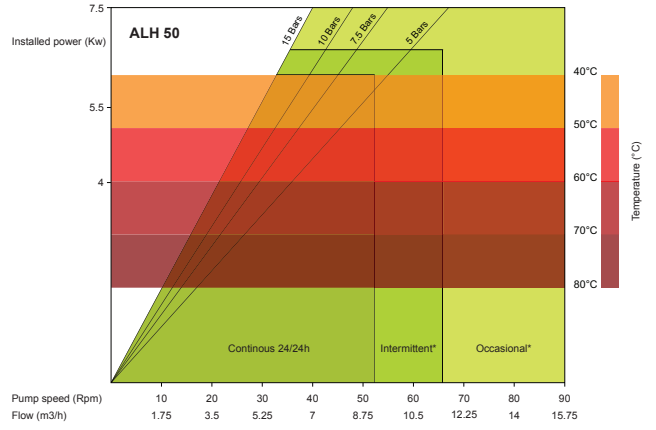
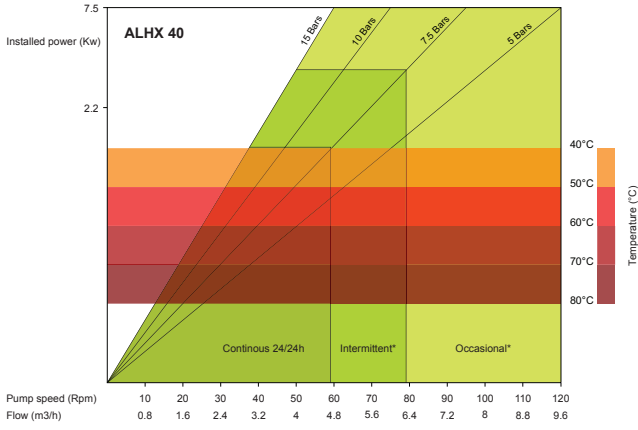

* Intermittent use: Minimum of 1 hour stop after 2 hours use * Occasional use: Maximum 1 hour per day



Albin Pump SAS
ZAC de Fontgrave
26740 Montboucher sur Jabron
France
Tel +33 (0) 4 75 90 92 92
Fax +33 (0) 4 75 90 92 40
info@albinpump.fr
www.albinpump.fr

Albin Pump AB (Headoffice)
Ålegårdsgatan 1
S-431 50 Mölndal
Sweden
Tel +46 (0)31 701 38 30
Fax +46 (0)31 22 14 37
info@albinpump.se
www.albinpump.se